

Submittal Data Sheet

Features and Benefits:

- **Five year parts and one year labor limited warranty***
- Standard 19 mm and 30 mm connections
- Wall, console, ceiling & surface mount designs available
- Compensates for variation in wall thicknesses up to 7/8"
- Modular gangable design
- All outlets are 100% tested for flow and leaks
- Gradate Full faceplate color coding

*See Terms and Conditions, Document No. 99-0477, on our website at: www.tri-techmedical.com for complete details.

Specification

The medical gas wall outlets shall be Tri-Tech Medical AGSS (evacuation) outlets for low pressure gas scavenging with 19 mm and 30 mm taper fitting for easy connection to standard anesthesia gas disposal tubing. The outlets shall be modular singles, and shall incorporate full faceplate color-coding. The single modular outlets shall be of a design that provides for ganging of rough-in plates in the field to form multiples. The gas services shall be sequentially arranged and located as shown on the plans with a minimum centerline spacing of 5 inches (12.7cm) between outlets.

The outlet nameplate shall be permanently gradate color-coded. The outlet faceplate shall be chrome plated zinc, attached with the nameplate to the rough-in assembly, and provide automatic plaster adjustment from 1/2 to 7/8 of an inch (13 to 22 mm). The name of the gas service shall be permanently embossed on the outlet bracket. The outlet's rough-in supply tube shall be a 7 inch (18 cm) length of 3/4 OD copper Type K, and labeled with the name of the gas service.

Medical gas outlets shall be cleaned for oxygen service in accordance with the current Compressed Gas Association (CGA) Pamphlet G-4.1, capped and placed in a protective container for shipment. The outlets shall be installed in strict accordance with manufacturer's instructions, and tested before use in conformance with local and federal codes.



XF1133 Recessed Wall Outlet Shown Above

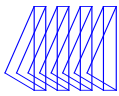

Layout

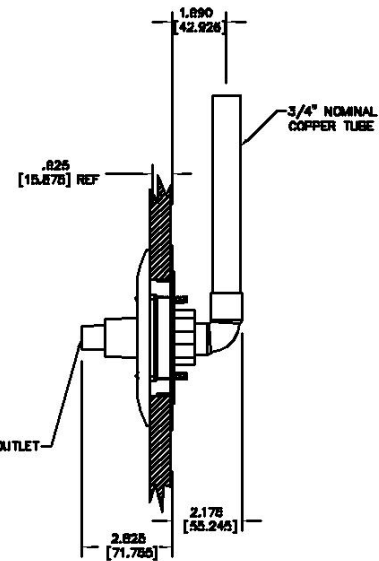
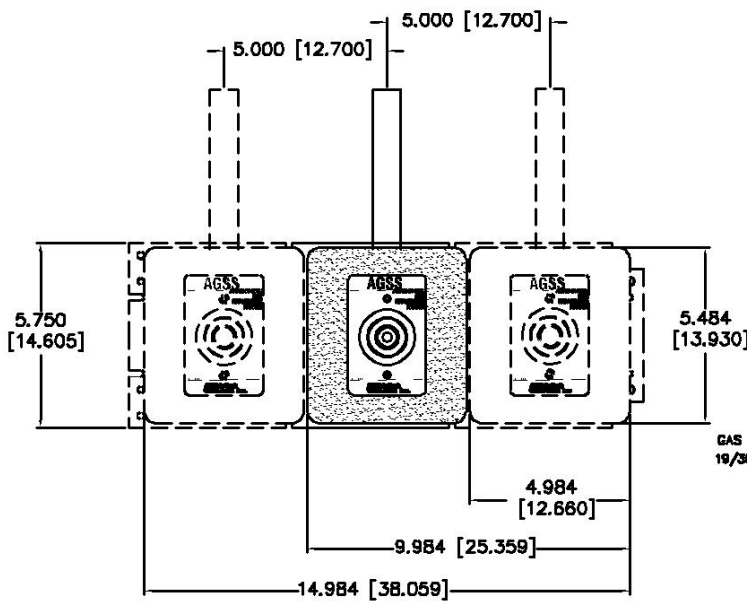
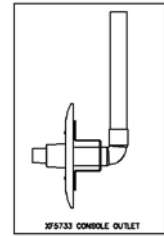
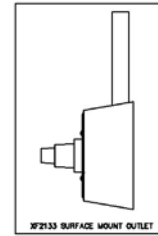
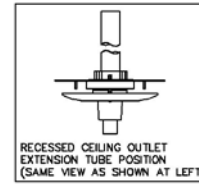
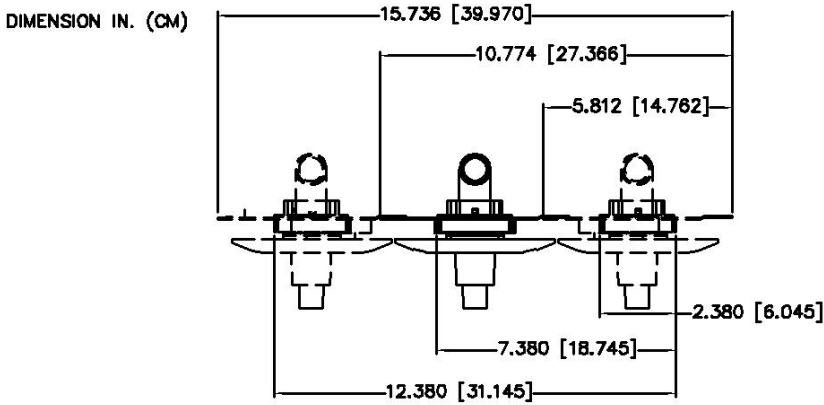

Ordering Information

Standard Recessed Outlets Complete - with the Trim Plate

Gas Service	Recessed Wall	Recessed Ceiling	Surface Mount	Console
AGSS NFPA	XF1133	XF1233	XF2133	XF5733
AGSS ISO English/French	NSI12XF1133	NSI12XF1233	NSI12XF2133	NSI12XF5733

To place an order or request additional information call toll-free 1-800-253-8692 or fax us at 1-440-937-5060 or email us at internationalsales@tri-techmedical.com. Please visit our web-site at www.tri-techmedical.com.