

Submittal Data Sheet

Features

The Tri-Tech Med Touch area alarm zone valve panel digitally displays gas pressure (1 psi increments) and provides alarm conditions as required by the latest edition of NFPA 99 for up to 7 medical gases. The alarm is ETL listed to UL 1069 and CSA C22.2 # 205 Signal equipment. Transducers are included.

- **Five-year parts and one year labor limited warranty**♣
- Individual 2.85” LCD touch screen display for each gas service
- The LCD touch screen allows all alarm programming and set up to be done without the use of tools
- A green normal or red alarm condition for each gas service confirms the condition for each individual gas service
- Emergency preparedness instructions - Med Touch alarm panels allow users to set up customized instructions for each alarm signal which appear when the signal is in alarm
- Last event history (per gas board /signal point).
- Made in the U.S.A.
- NFPA and ISO pre-loaded gas ‘labels’
- English, English/French English/ Spanish pre-loaded languages
- Editable text and alarm ‘labels’
- Self-contained unit designed for ease of installation & service
- Self-diagnostic error message display for ease of maintenance
- Audio and visual alarm indicators
- Bright easy to read LCD displays – clearly visible in both day and night lighting conditions
- Constant display and monitoring of each gas
- User programmable high/low set points
- Dry contacts for remote monitoring of all alarm conditions on each gas module and on the CPU module for the entire panel
- Easy to read – color coded gas modules
- Hinged frame for easy accessibility
- Color coded displays
- Does not require re-calibration
- Gas specific sensor with DISS nut & nipple. An error message will be displayed if incorrect sensor or no sensor is attached.
- Shall be capable of displaying gas readouts in PSI, kPa, BAR, inHg, or mmHg.
- Gas alarm repeat feature is factory set at 10 minutes, and is adjustable or may be turned off
- All valves are dual gauge port full port ball valves
- 3 piece in-line repairable valves
- Adjustable packing with blow-out proof stem design
- Accommodate up to 7 valves sizes from 1/2” to 2”
- Working pressure rating of 3-piece valve body 600 psi WOG (29 inHg vacuum)
- All valves cleaned for Oxygen service
- Plastic insulators to protect from galvanic corrosion
- Provided with 1 ½” diameter gauges
- “Smoked” Translucent flexible plastic window provided with all models except ISO English/French
- White Opaque flexible plastic window provided with ISO English/French models.

♣ See Terms and Conditions, Document No. 99-0477, on our website at: <https://tri-techmedical.com> for complete details.



Specification

All area alarm zone valve panels shall be the Tri-Tech Medical Z T series and must be installed and tested in strict accordance with NFPA 99 standards and or any other local codes before use.

The alarm/ zone valve shall be the Tri-Tech Medical Integrated Area Alarm/ Zone Valve Panel. The panel shall be microprocessor controlled and designed to comply with NFPA 99. The panel shall be 100% digital and shall not require re-calibration. The unit shall be enclosed in a steel box and shall be designed to accept an electrical input range of 120-240 volts AC – 50-60 hertz. The source voltage shall be stepped down with a self-contained transformer. The panel shall contain audible and visual alarm indicators. The audible alarm may be silenced by pressing the alarm silence button, but the visual alarm indicator can only be cancelled by fault correction. The alarm shall detect and filter out transient (less than 0.6 seconds) signals created by R.F.I. The alarm shall be capable of displaying alarm history for all possible alarm conditions.

The alarm shall be capable of monitoring and displaying up to 7 gases per alarm panel. Gas modules can be arranged in accordance with the customer’s requirements.

Valves – The valves shall be dual gauge port, cast bronze, ball-type, with Teflon (TFE) seats and seals. 3-piece valve bodies shall be rated at working pressure of 600 psi (29 inHg vacuum) and shall be operated by a lever-type handle, requiring only a quarter turn from a fully open position to a fully closed position. Valves shall incorporate an adjustable packing and a blow-out proof stem. Only full port valves having flow rates comparable to equivalent size of pipe shall be used. Valves shall be piped from left to right.

All valves shall be provided with type K copper tubing extensions to facilitate installation. Valves shall be 3 piece in-line repairable type. Each valve assembly shall be supplied cleaned for oxygen service in accordance with current CGA standards. The valve tube ends shall be capped and sealed in a protective container to prevent contamination prior to installation.

Gauges shall be 1 ½” diameter for monitoring pressure and vacuum, and shall state: “USE NO OIL”. Dual scale gauges are not acceptable for the U.S.A. installations.

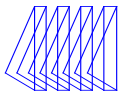

The following options shall be able to be added to the panel at the time of order or after installation;

- Optional Text / e mail notification of alarm events sent to up to 5 addresses
- Optional Ethernet module. This module may be added to any alarm panel. It will provide the following features:
 - Webservice – allows a remote user access to the alarm’s webpage – viewing a graphic image of the alarm with all signal conditions, pressure & event / history log information
 - Text notification of alarm conditions (up to 5 addresses)
 - Event / history log – maintains a rolling list of the 100 most recent alarm condition events and a file of the 1,000 most recent alarm events and is downloadable through embedded web page
- Modbus interface
- Event log is viewable and downloadable through embedded web page, including the most recent 1,000 events.
- Optional Ethernet connectivity with embedded web page
- Interface with building automation system via Ethernet

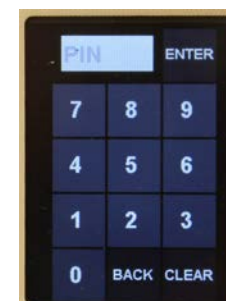
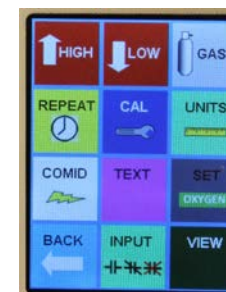
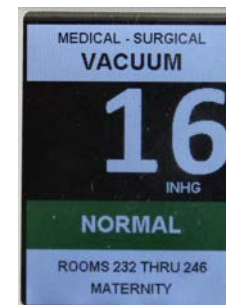
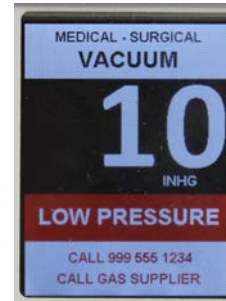

Gas / Area Display

Shown in alarm condition displaying rooms/area monitored. Display blinks on and off when in alarm condition drawing attention and alternates displaying rooms/area monitored with user programmed emergency instructions.

Shown in alarm condition displaying emergency instructions. Display blinks on and off when in alarm condition drawing attention and alternates displaying rooms/area monitored with user programmed emergency instructions.

Shown in normal condition. Code specific gas colors, and gas name are displayed at the top in facilities language. Gas pressure and units of measure are displayed in the middle of the screen. Normal or Alarm condition is displayed in the bottom center. Rooms/area monitored alternates with user programmed emergency instructions at the bottom.

Easy to use icon menu provides quick access to programming options.

Security is built in to each circuit board. The correct four-digit pin code must be entered in order to access the programming software.

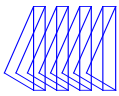

Box – The valve box shall be 18-gauge sheet steel construction painted to prevent rust. A single box shall house from one to seven valves. Box shall be supplied with an adjustable plaster flange ½” to 1 1/8” for easy mounting.

Window – Valve box assembly shall be supplied with a formed steel decorative frame painted white which encloses an easily removable

flexible window. The window shall be a “smoked” translucent on NFPA models and a white opaque on ISO English/French models, flexible plastic with a pull-out ring pre-mounted to the center of the window. The window shall not be replaceable while any valve is in a closed position. Window shall be silk screened with the following statement “CAUTION: MEDICAL GAS SHUTOFF VALVES. CLOSE ONLY IN EMERGENCY.”

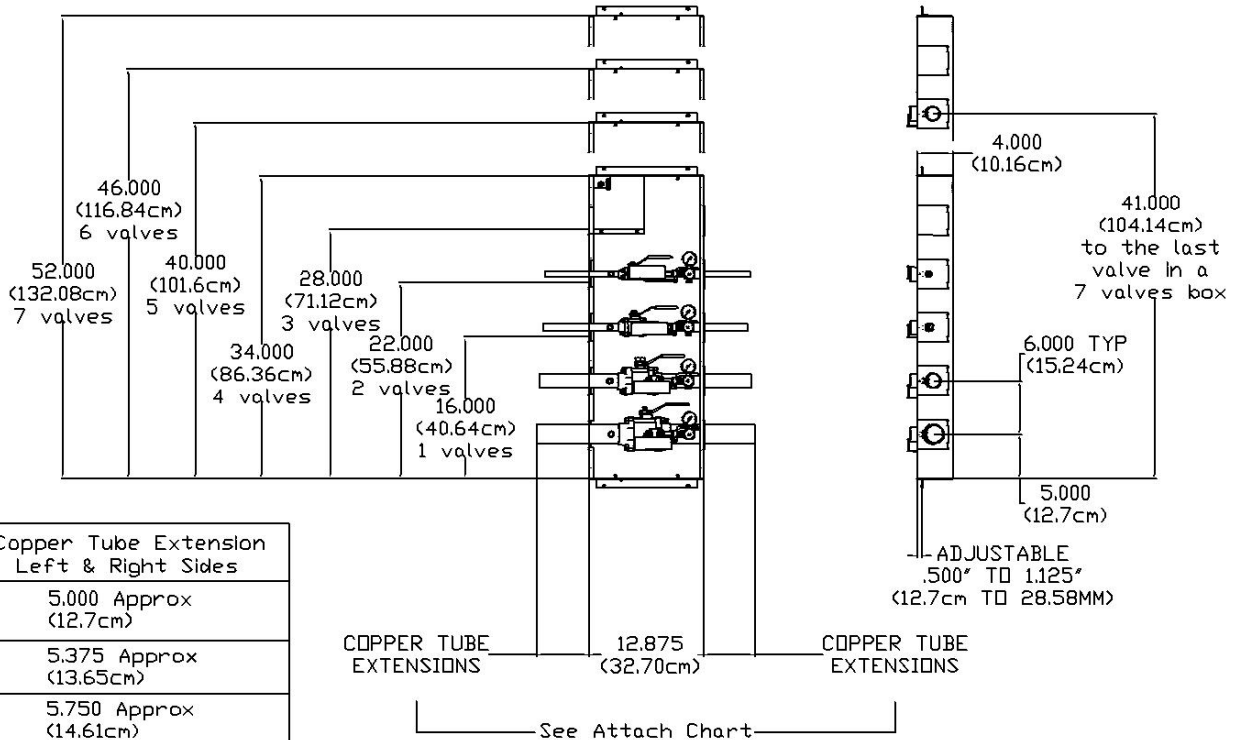

Valve Size	Copper Tube Extension Left & Right Sides
1/2", 3/4", 1", 1-1/4"	5.000 Approx (12.7cm)
1-1/2"	5.375 Approx (13.65cm)
2"	5.750 Approx (14.61cm)

Rough Opening Height Dimension for "X"

	IN	CM
1 valve	16.125	40.96
2 valves	22.125	56.20
3 valves	28.125	71.44
4 valves	34.125	86.68
5 valves	40.125	101.92
6 valves	46.125	117.16
7 valves	52.125	132.40

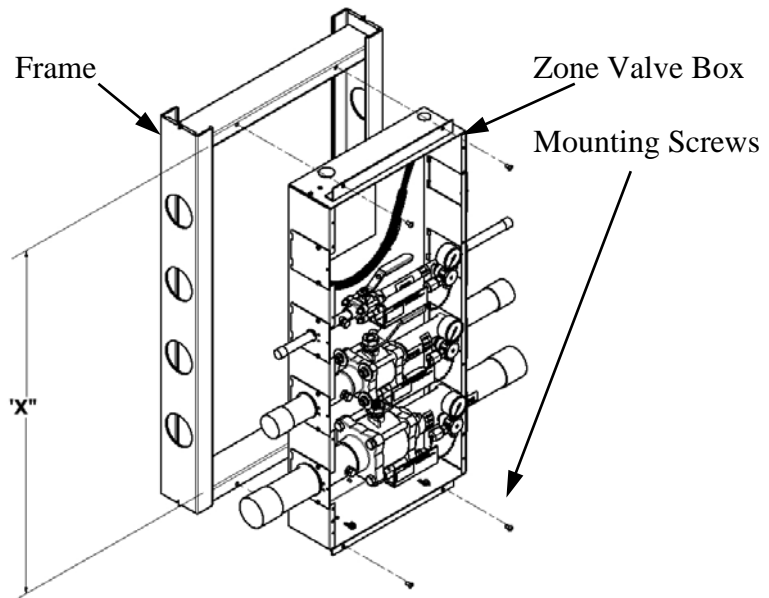

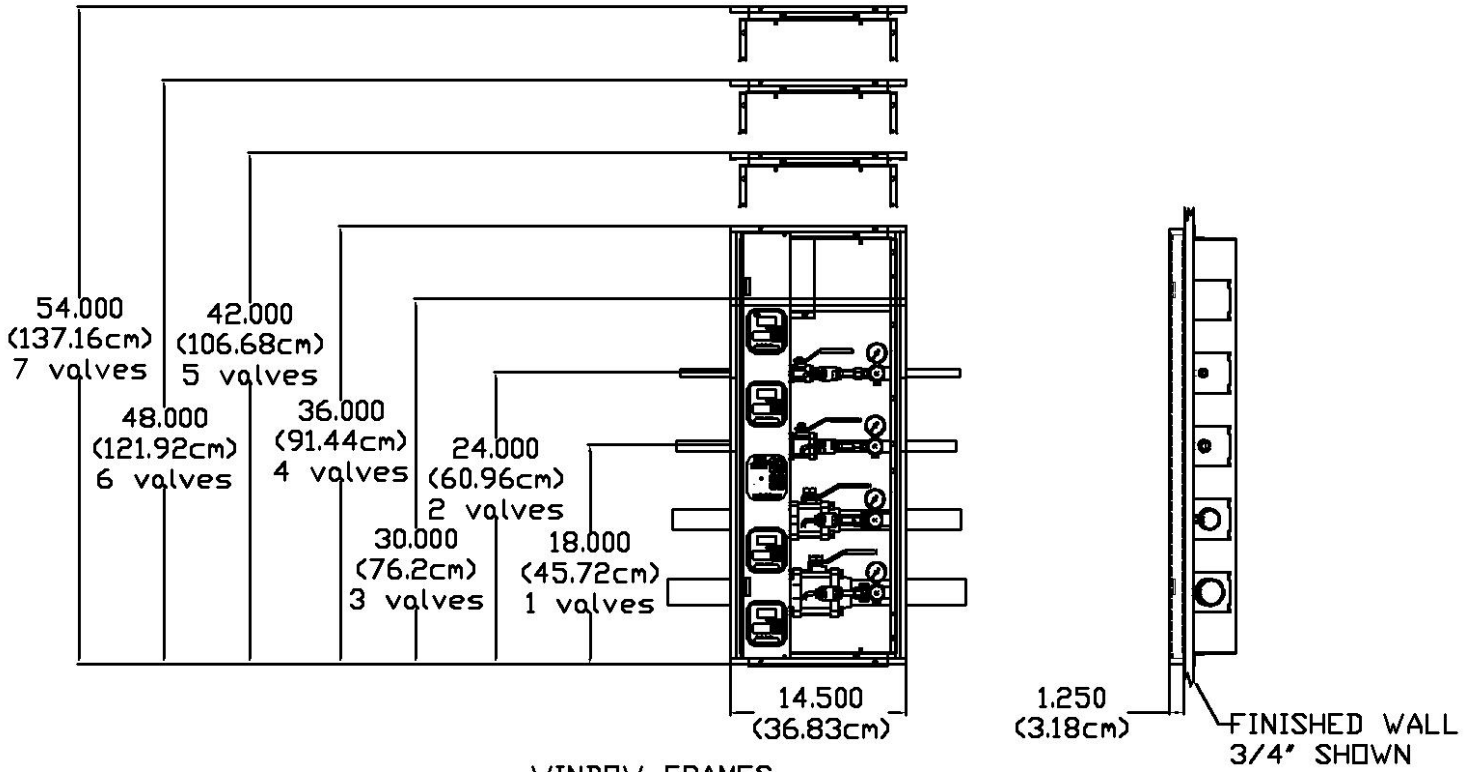
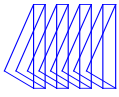

WINDOW FRAMES

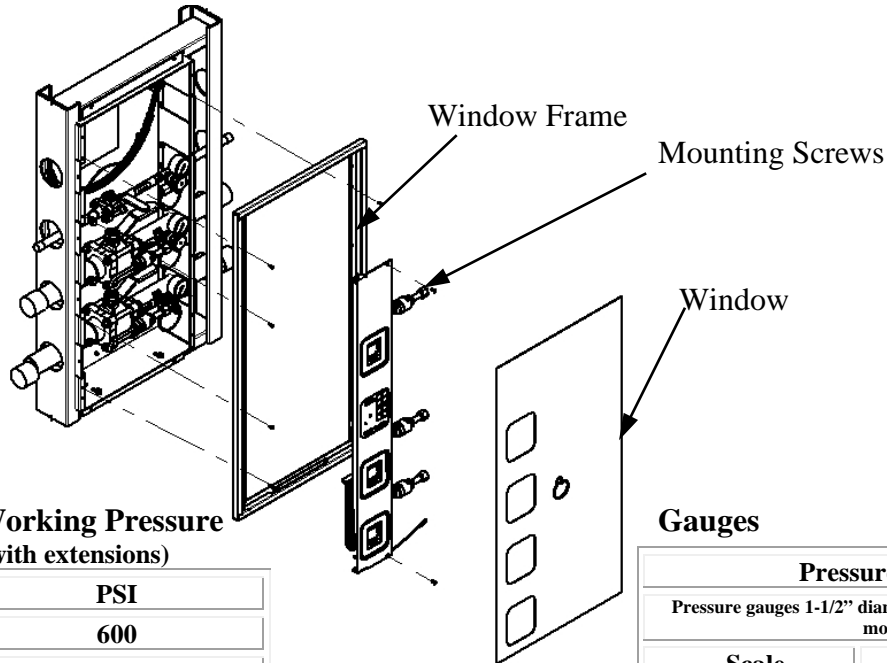

**Maximum Allowable Working Pressure
(Complete valve assembly with extensions)**

Size Valve	PSI
1/2", 3/4", & 1"	600
1 1/4"	525
1 1/2"	475
2"	425

Gauges

Pressure Gauge	
Pressure gauges 1-1/2" diameter 1/8" NPT center back mount	
Scale	Part Number
0-100 psi	14-1008
0-300 psi	14-1009
0-30 in Hg	14-1010

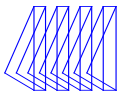

How to Order: Easy to use modular ordering system.

Fill in the blanks to specify the Med Touch Zone Valve Box that meets **your** needs.

Model Numbering:



Repeat the 2-character set for each valve



EZ 1 port for Transducer (included)

Note: a 35-3034 kit may be ordered separately and installed in the field to provide; Ethernet webserver, event log, alarm notifications may be sent up to 5 users via text or e-mail and Modbus Interface.

Note: a 35-3033 Ethernet programming kit is required and must be ordered when the 35-3034 kit is ordered. Only one is needed per facility.

G = Gas Service

- | | |
|---|---|
| A – Medical Air | V – Medical Vacuum |
| C – Carbon Dioxide – 50 psi | W- WAGD/EVAC |
| D – Carbon Dioxide – 80 psi | X – No Gas |
| E – Carbon Dioxide HP-100 psi | Y – Laboratory Vacuum |
| G – Argon | 2 – Dental Air |
| H – Hyperbaric Oxygen | 3 – Dental Vacuum |
| I – Instrument Air | 4 – Medical Vacuum / WAGD |
| J – Carbon Dioxide-Oxygen Mixt DISS 1080 (CO2>7%) | 5 – Medical Vacuum / AGSS |
| K – Helium-Oxygen Mixt DISS 1060 (He>80%) | < - Gas Mixture (uses 100 psi Transducer) |
| L – Helium | > - High Pressure Gas Mixture (uses 250 psi Transducer) |
| N – Nitrous Oxide | |
| O – Oxygen | |
| R – Tri-Gas | |
| S - AGSS | |
| T – Nitrogen | |
| U – Laboratory Air | |

S = Size of Valve

- | | | | |
|------------------|----------------|--------------|------------------|
| 2 – 1/2" valve | 3 – 3/4" valve | 4 – 1" valve | 5 – 1 1/4" valve |
| 6 – 1 1/2" valve | 7 – 2" valve | X – No valve | |

N = Number of Valves

1 Through 7

C = Country

- | | |
|---|--|
| U – Tri-Tech Labeled NFPA Color Code English | I – Tri-Tech Labeled ISO Color Code English/French |
| S – Tri-Tech Labeled ISO Color Code English/Spanish | N – Tri-Tech Labeled NFPA Color Code Spanish |

ZT = Touch Screen Digital

Part No. Examples

ZTU32A305V = 3 gas valve box and gauges on right side of all 3 valves with 1/2" AIR, 3/4" OXY, 1 1/4" VAC valves. NFPA Color Code English Displays.

ZTU22N30 = 2 gas valve box and gauges on right side of both valves with 1/2" N2O, 3/4" OXY valves, NFPA Color Code English Display.